

1

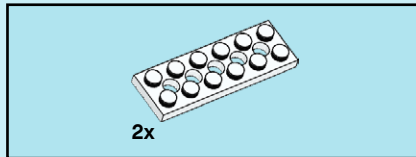

2

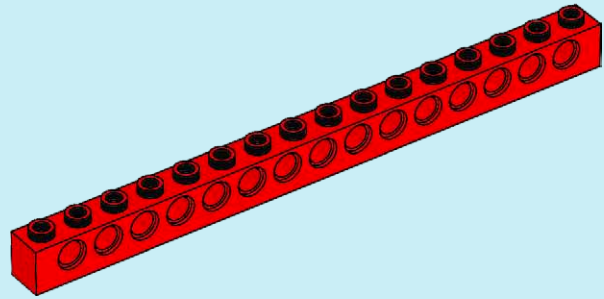

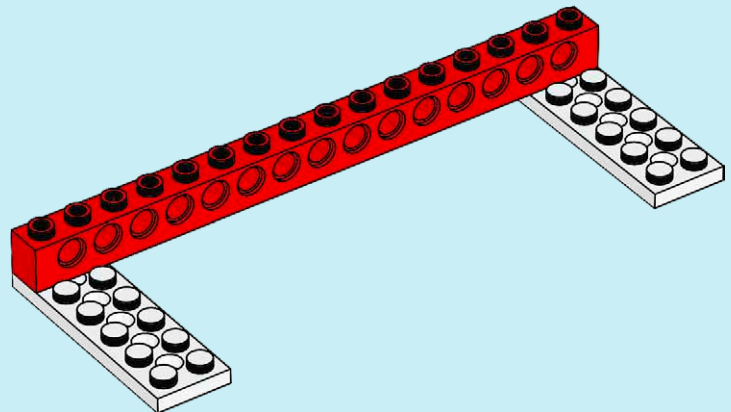
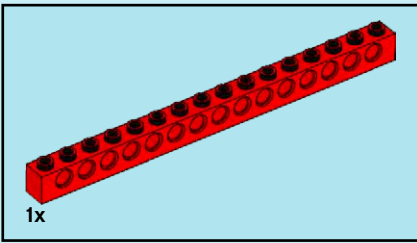

3

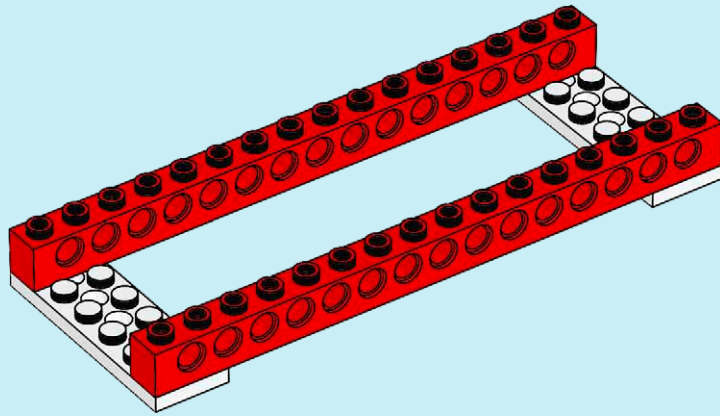

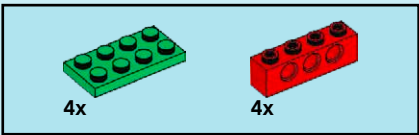

4

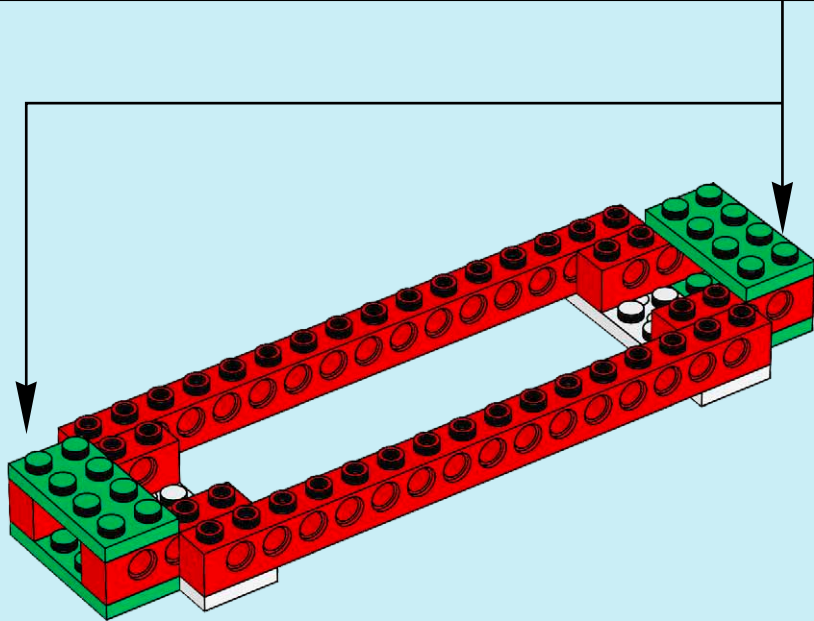
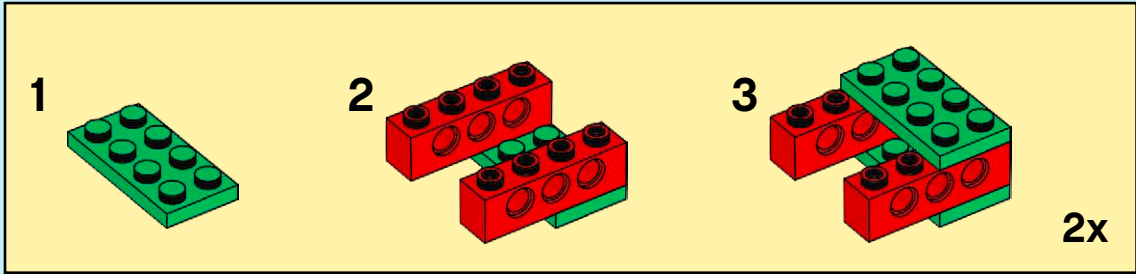

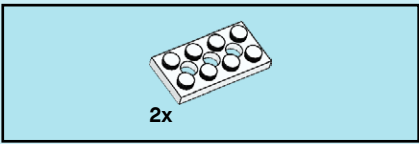

5

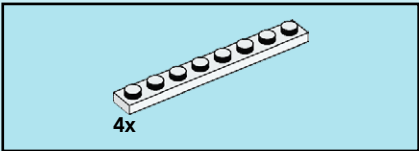
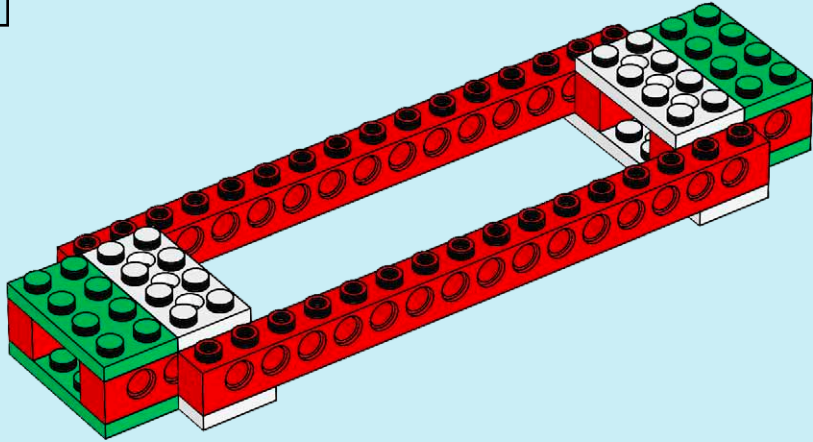

6

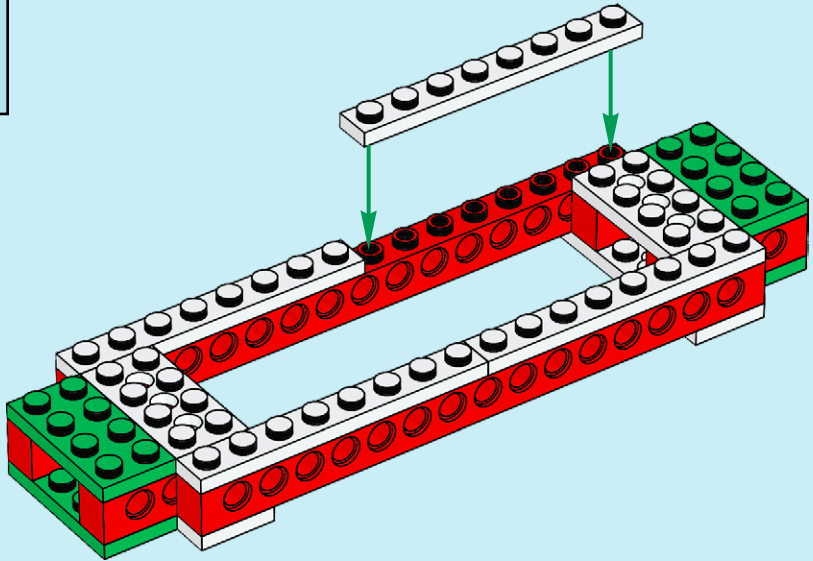

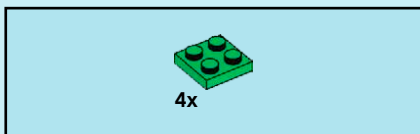

7

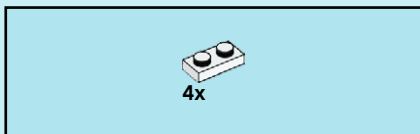
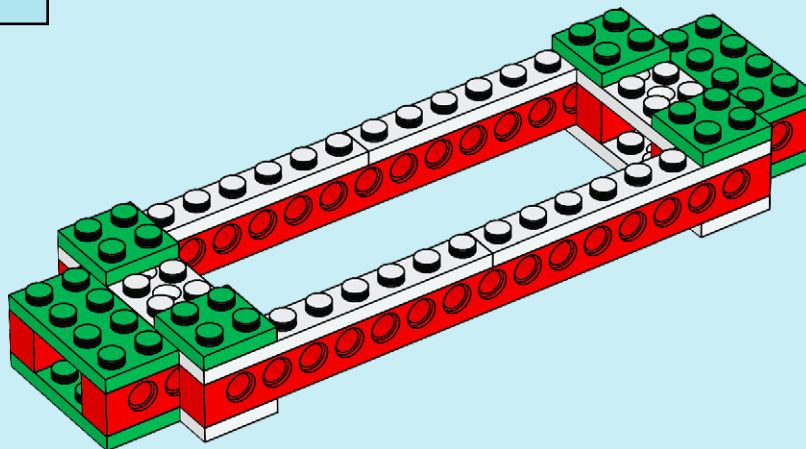

8

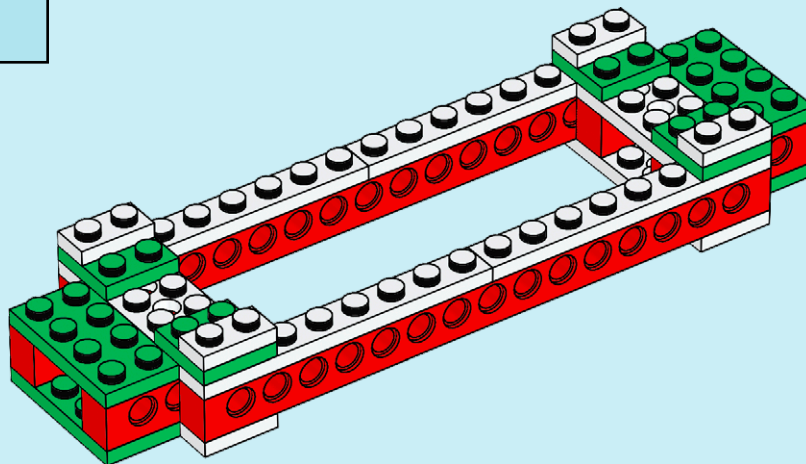

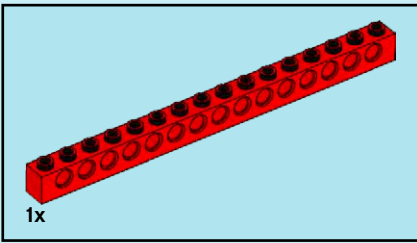

9

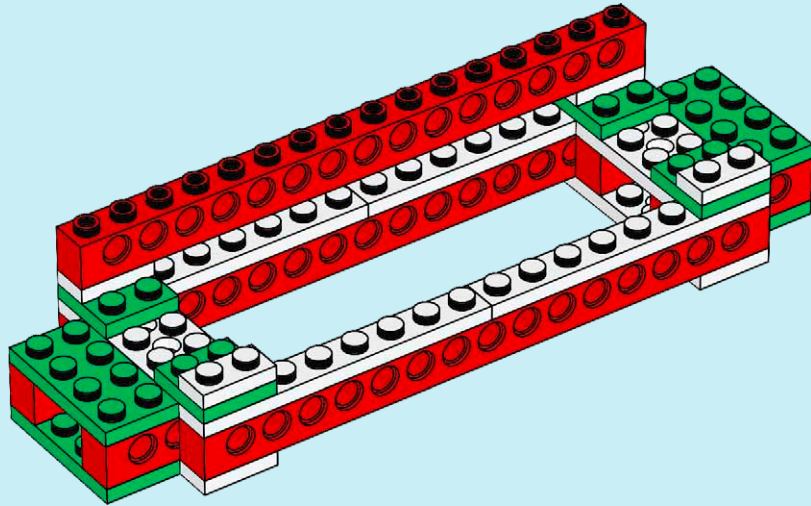

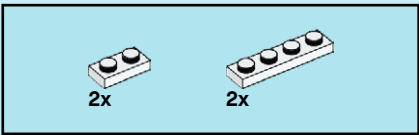

10

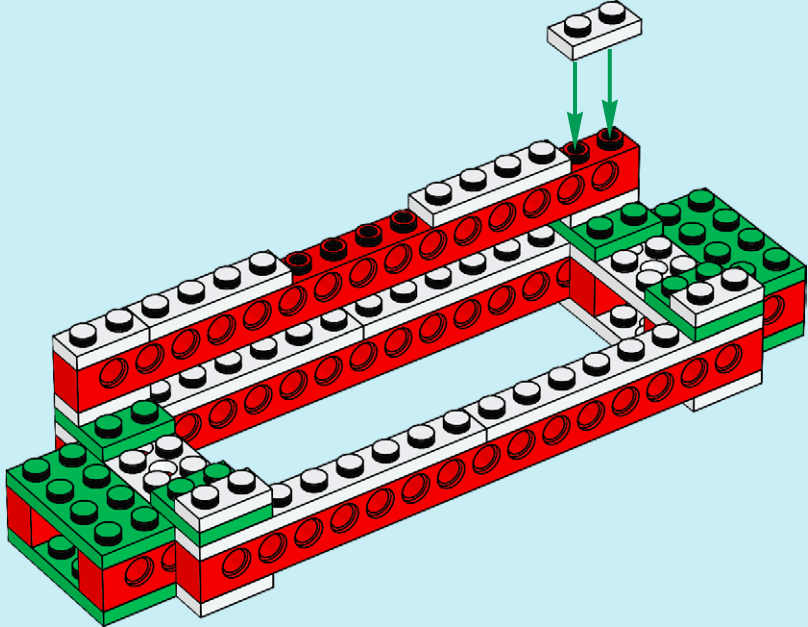

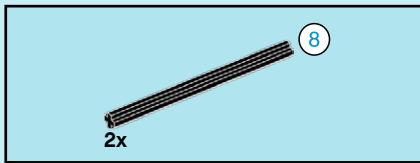

11

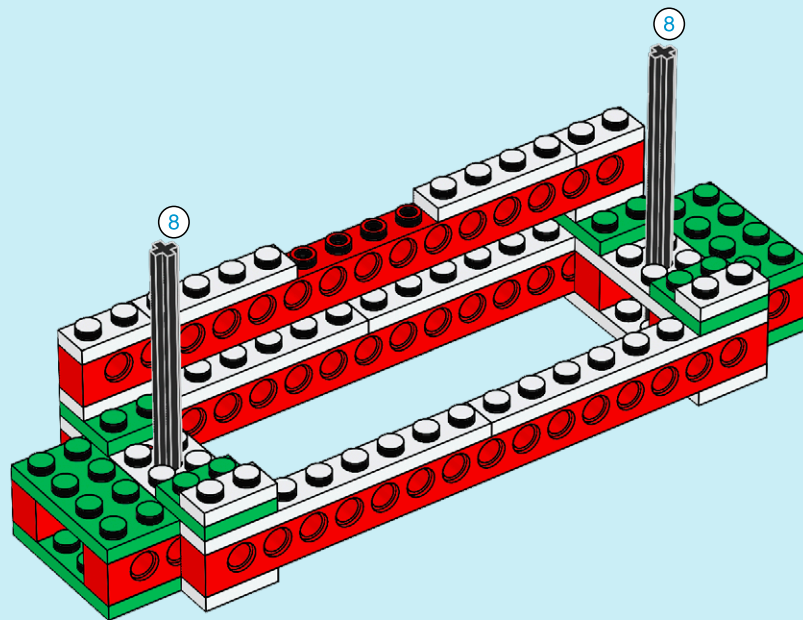

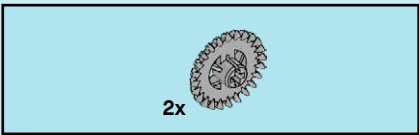

12

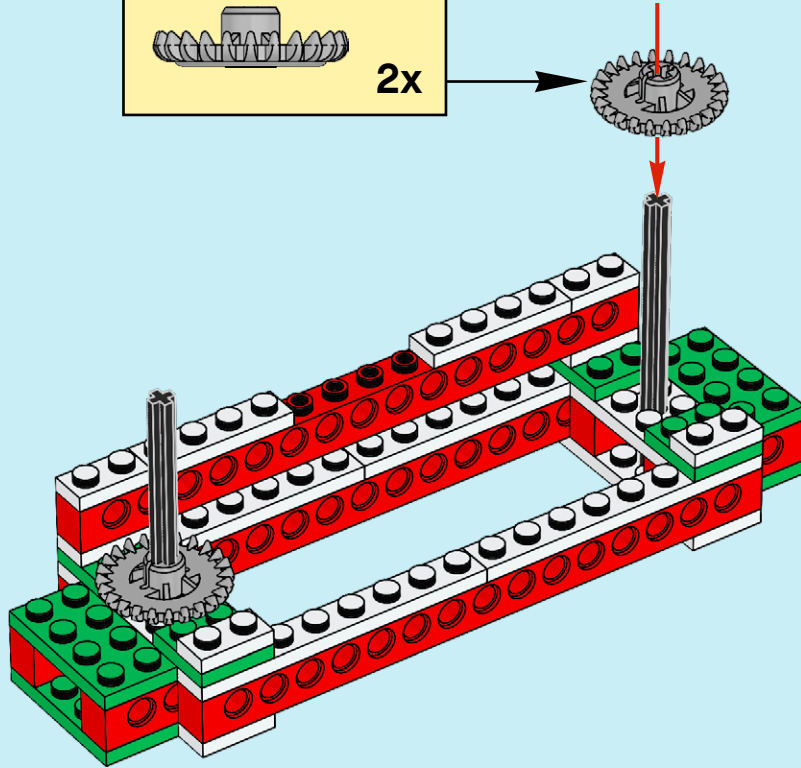
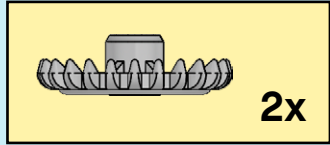

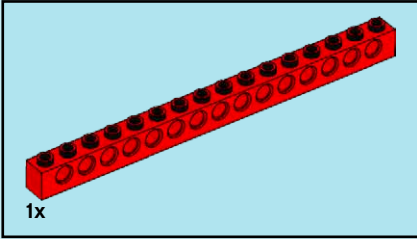
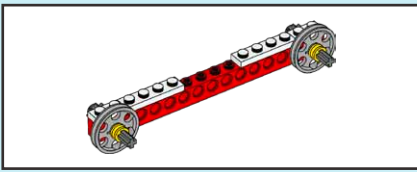

1

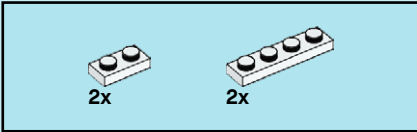
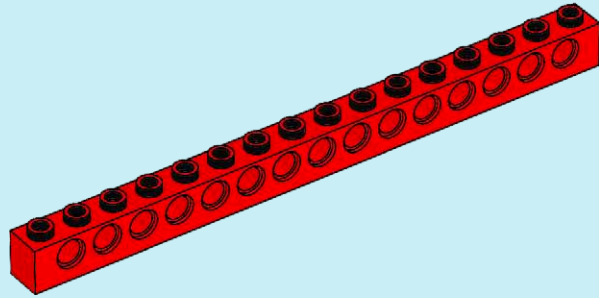

2

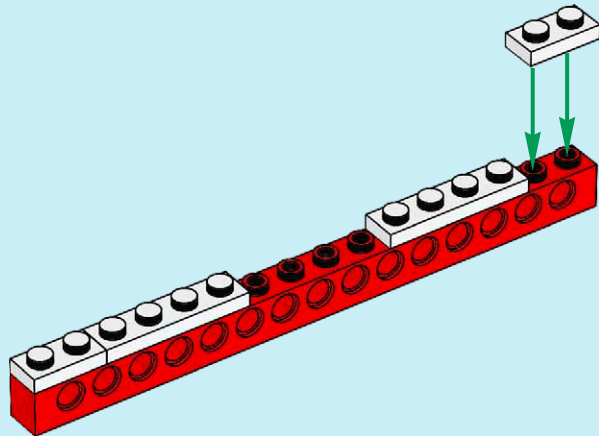

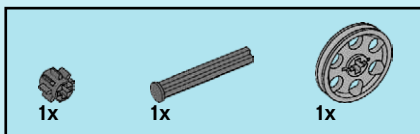

3

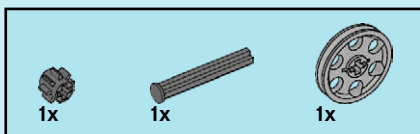
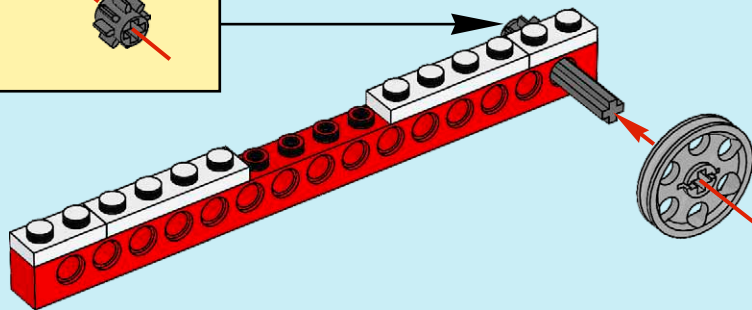
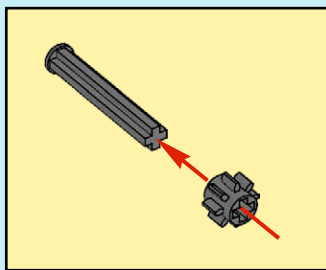

4

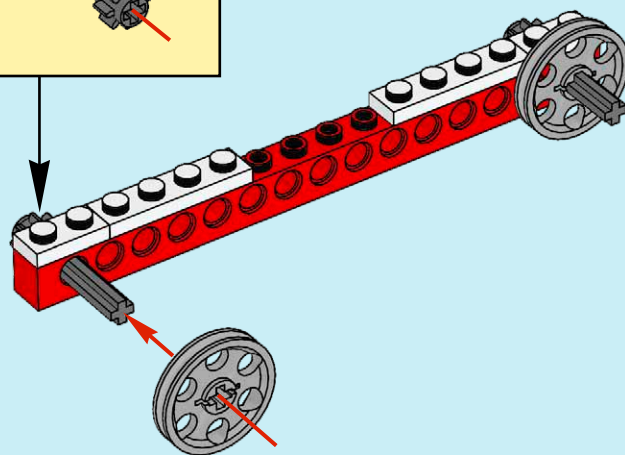
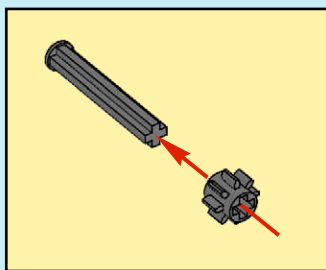

2x

5

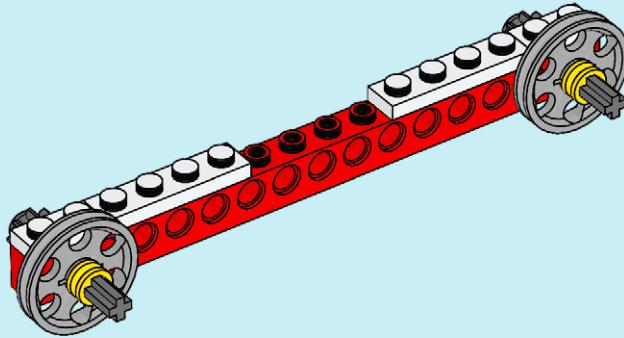

13

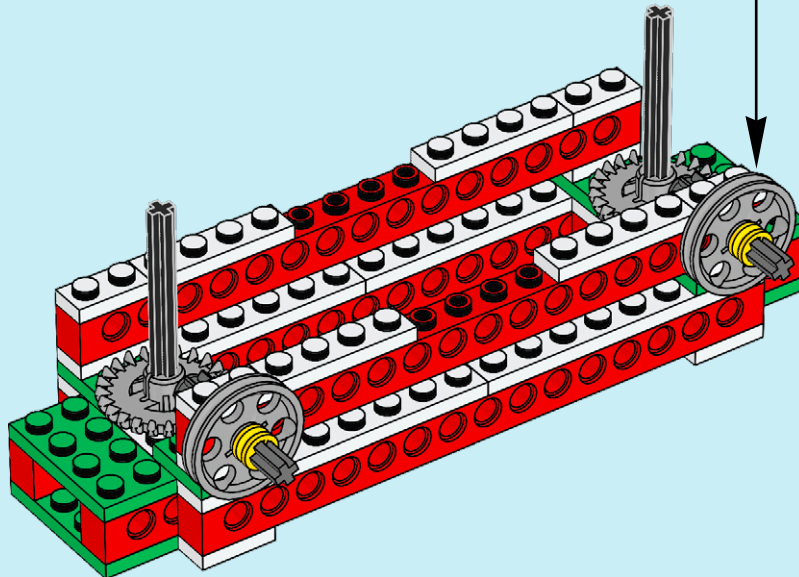

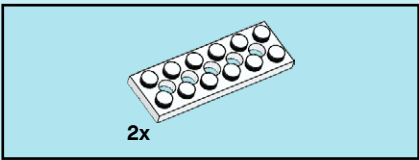

14

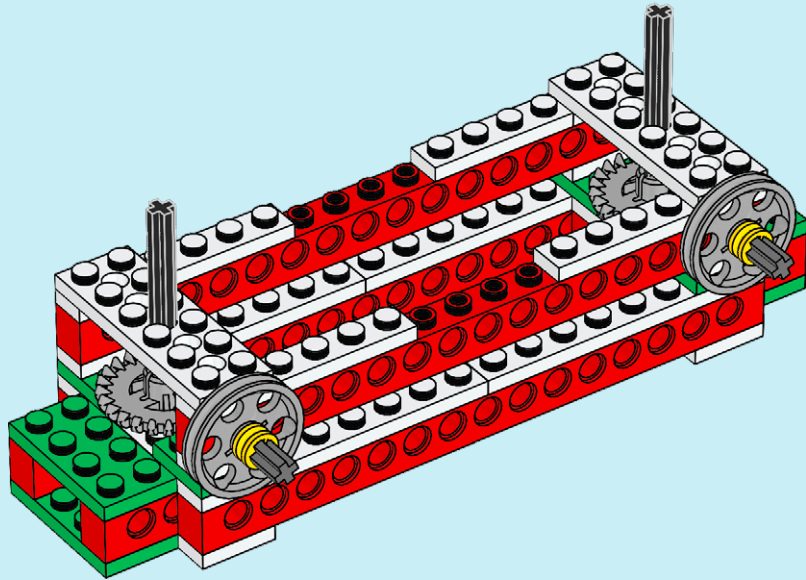

2x

15

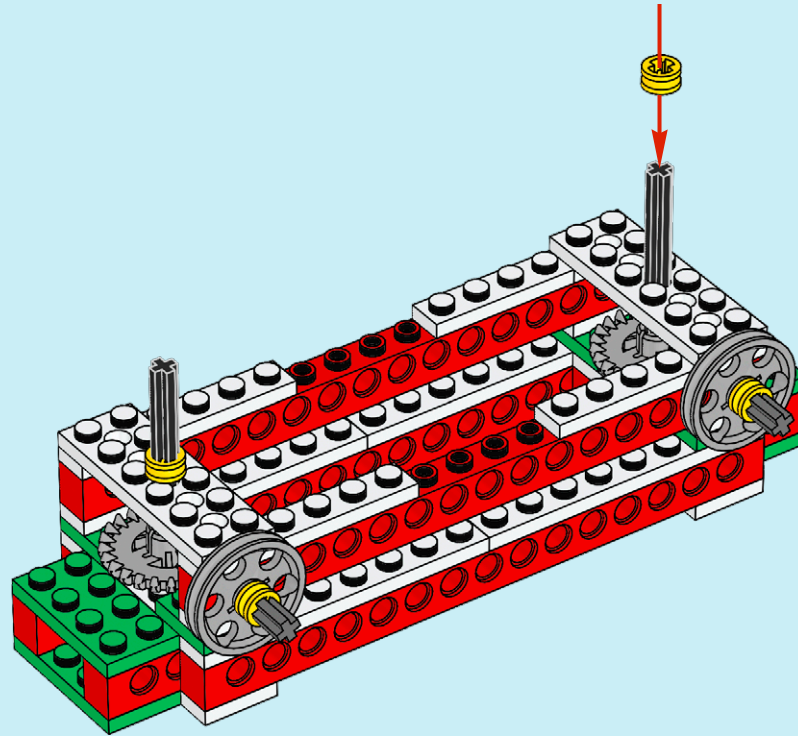

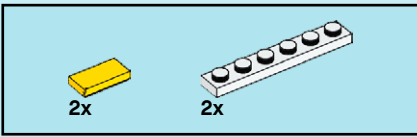

16

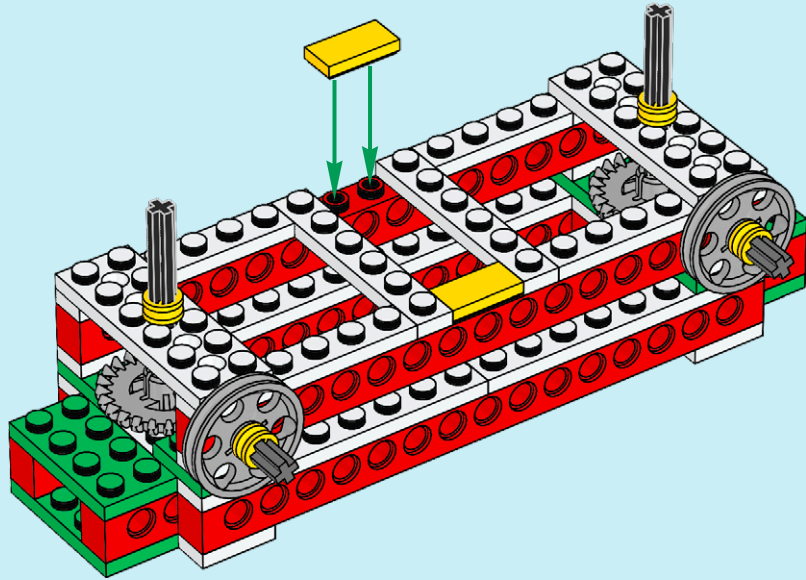

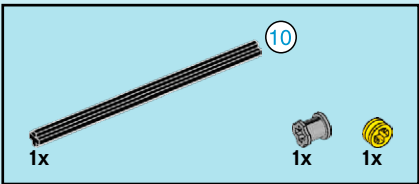

17

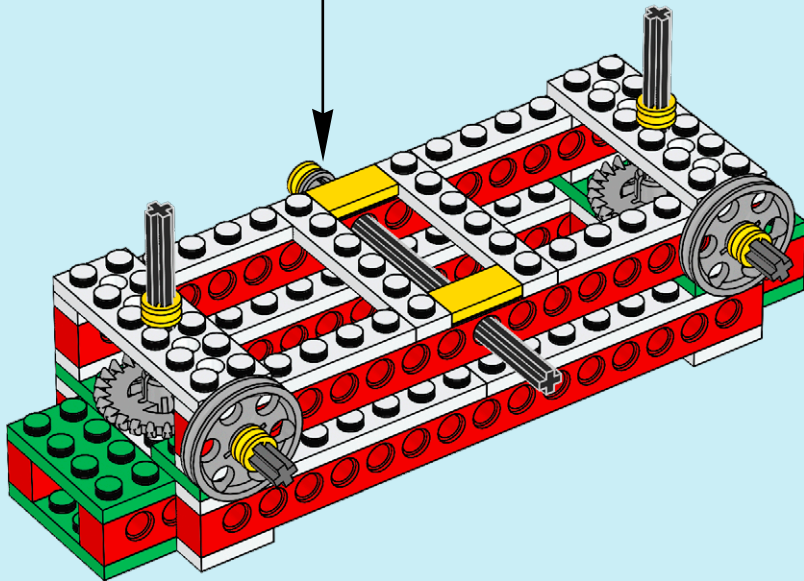
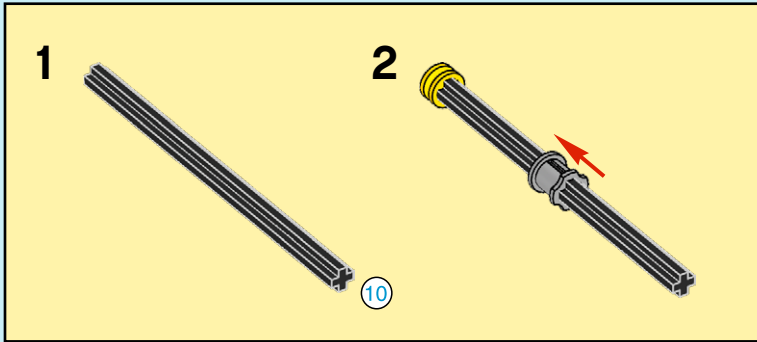

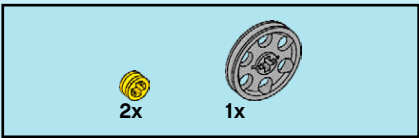

18

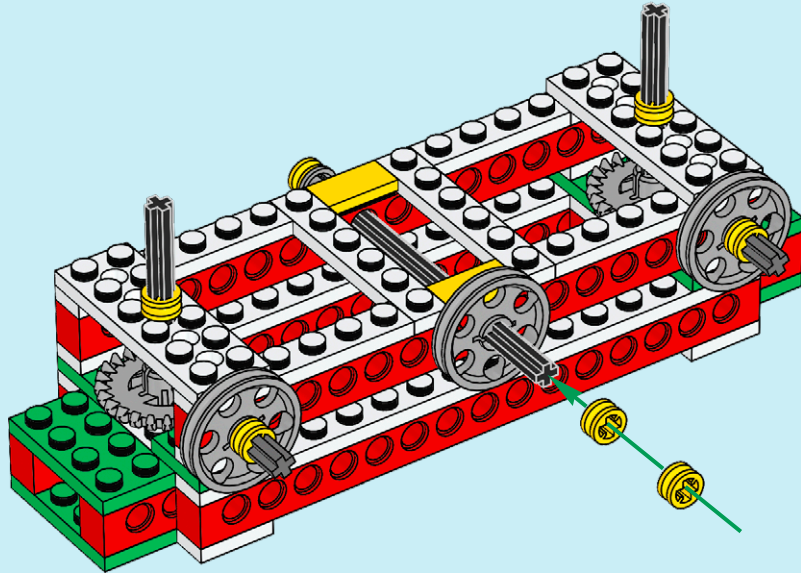

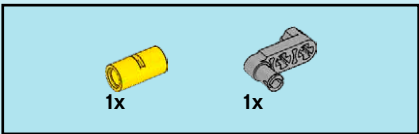

19

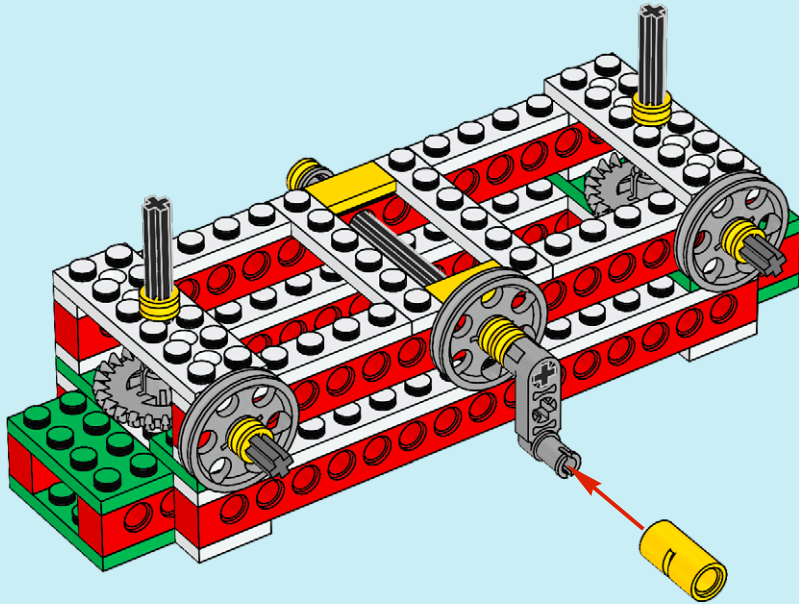

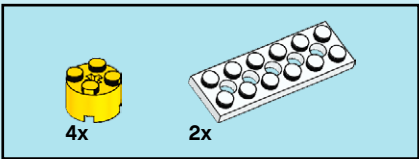

20

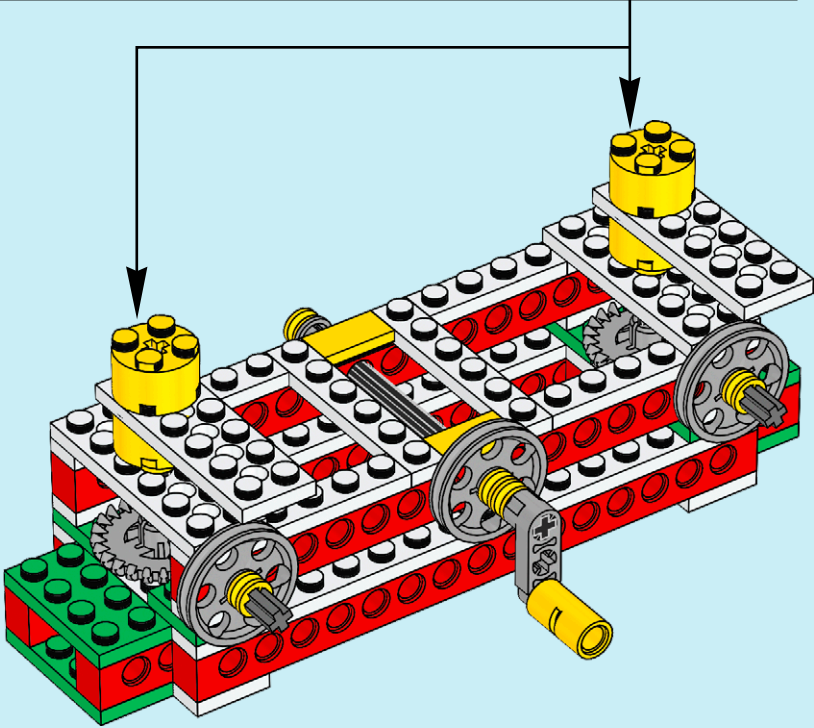
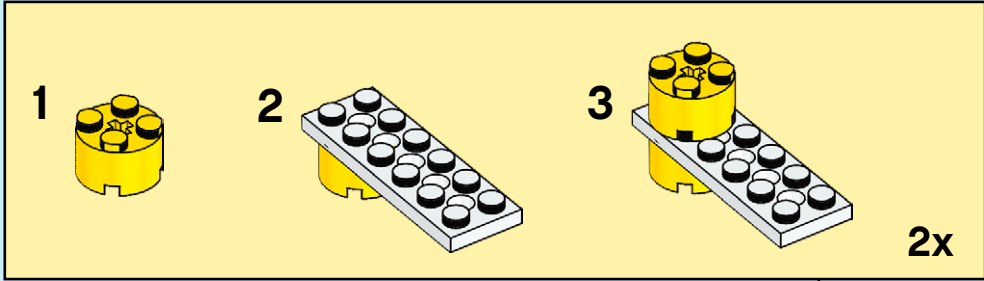

21

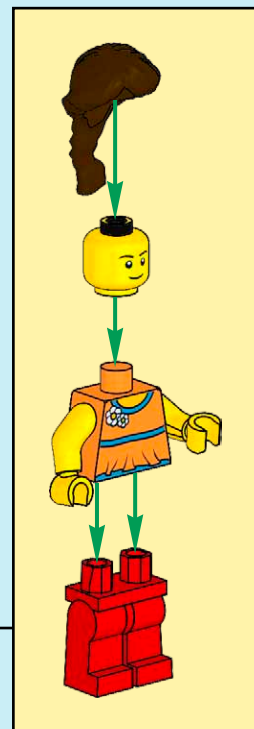
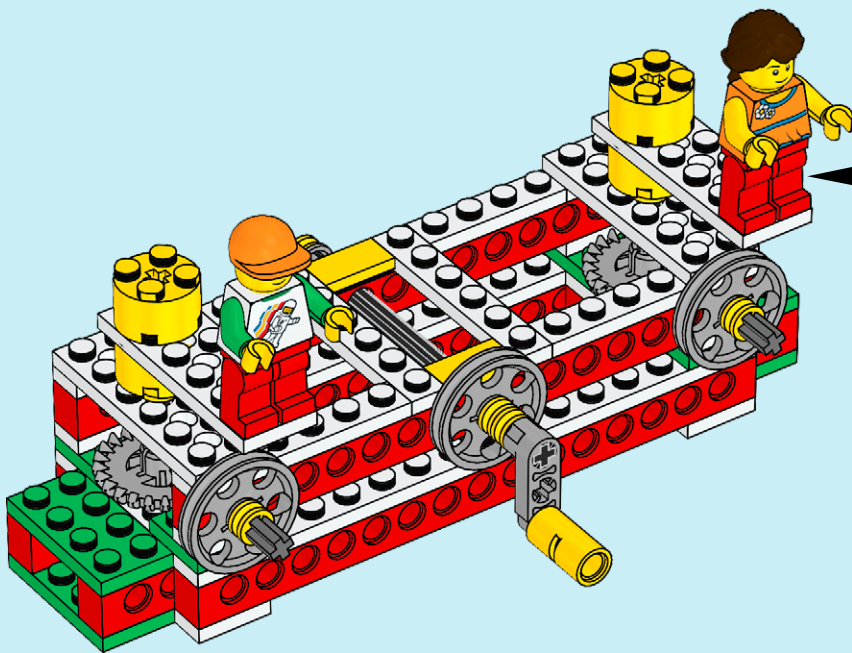

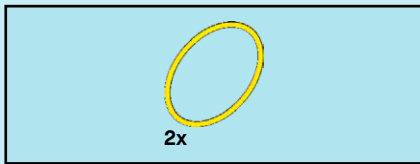

22

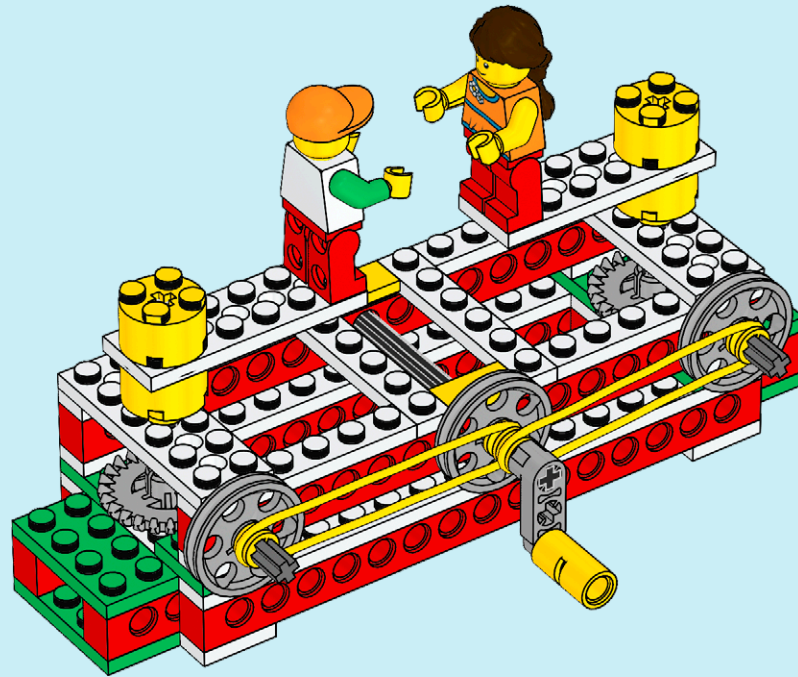



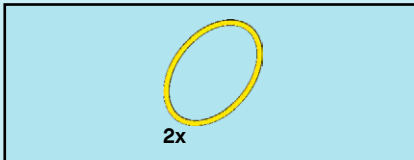
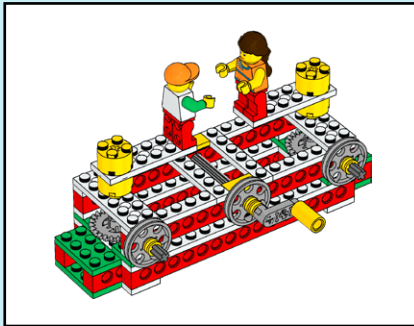

1

