

1

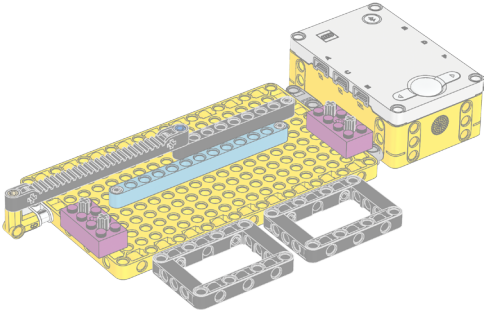

+

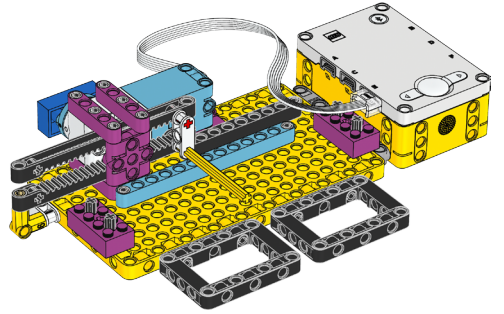

2

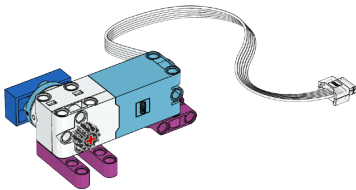

1 x



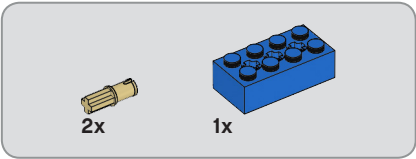
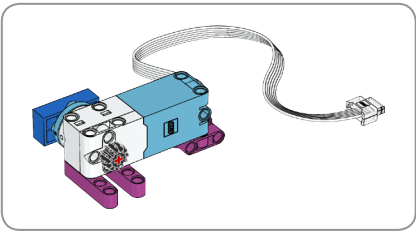

1

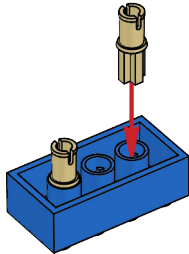

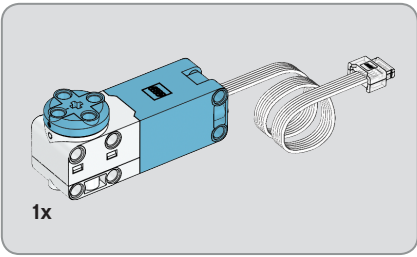

2

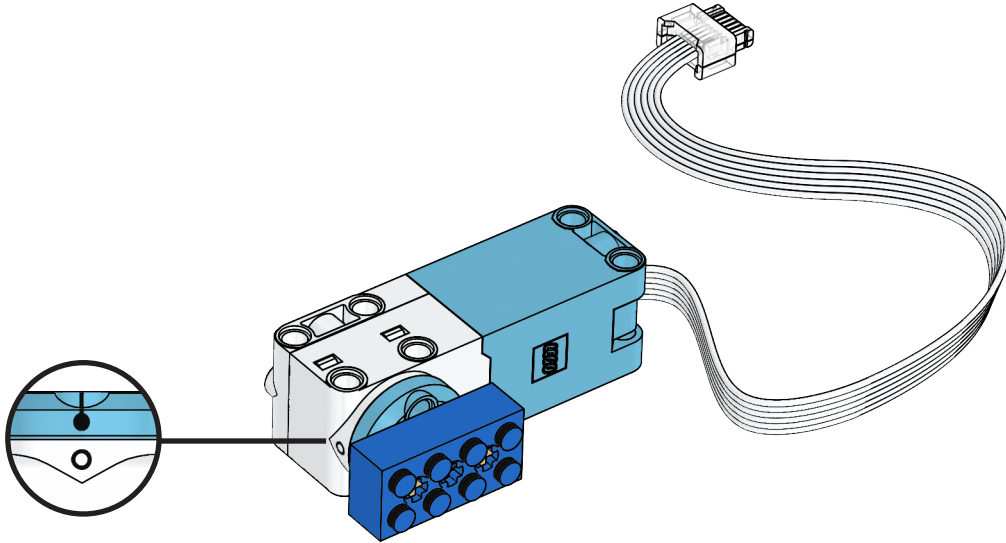



6x

3

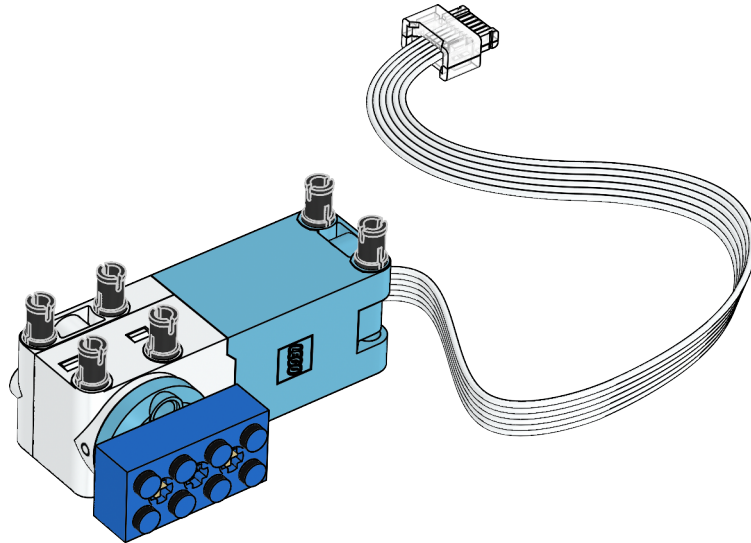

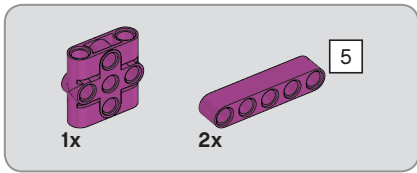

4

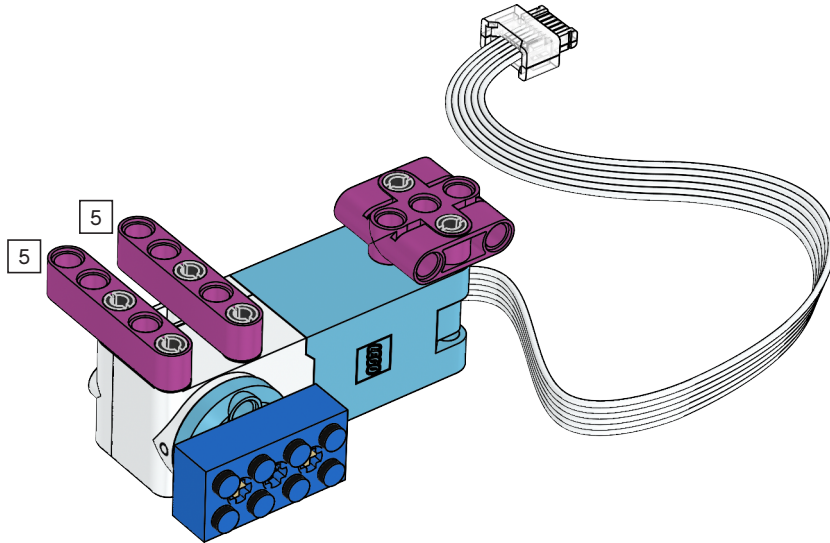



1x

5

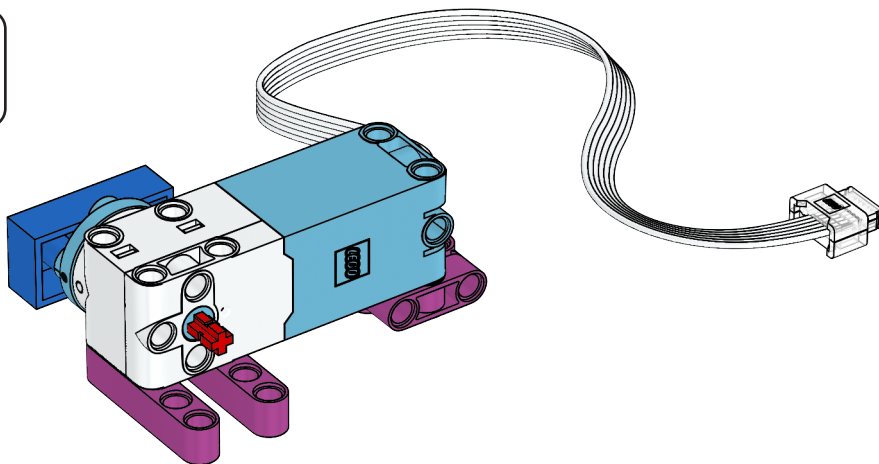



1x

6

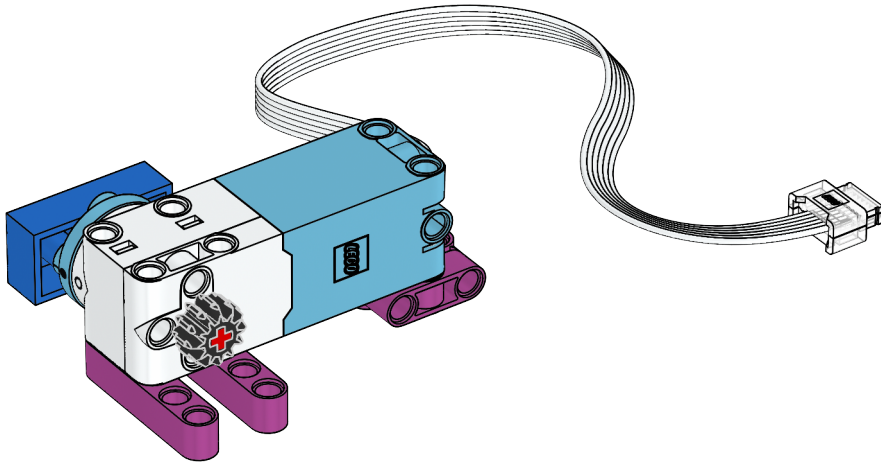



7

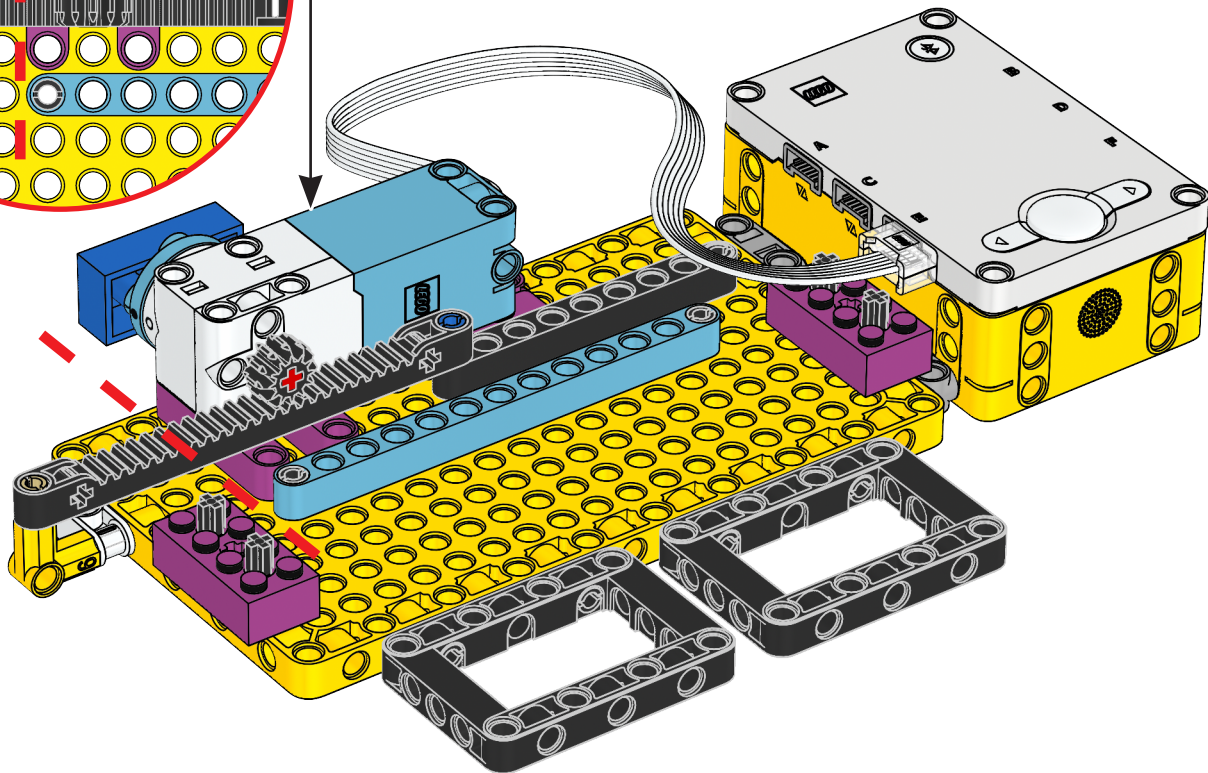
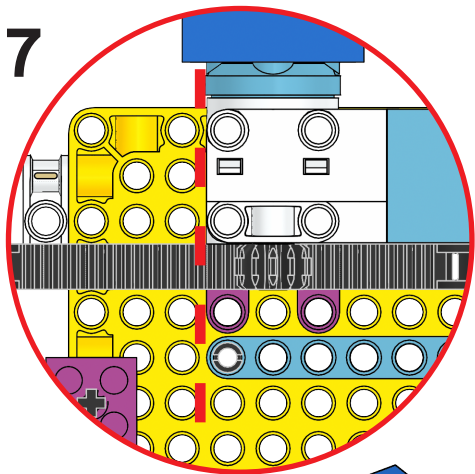

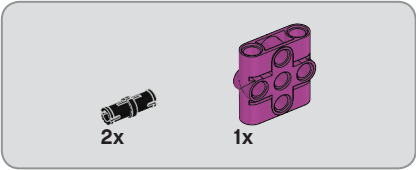
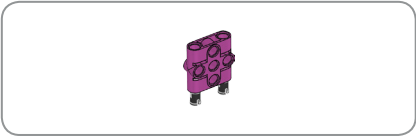

8

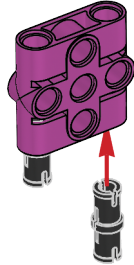

9

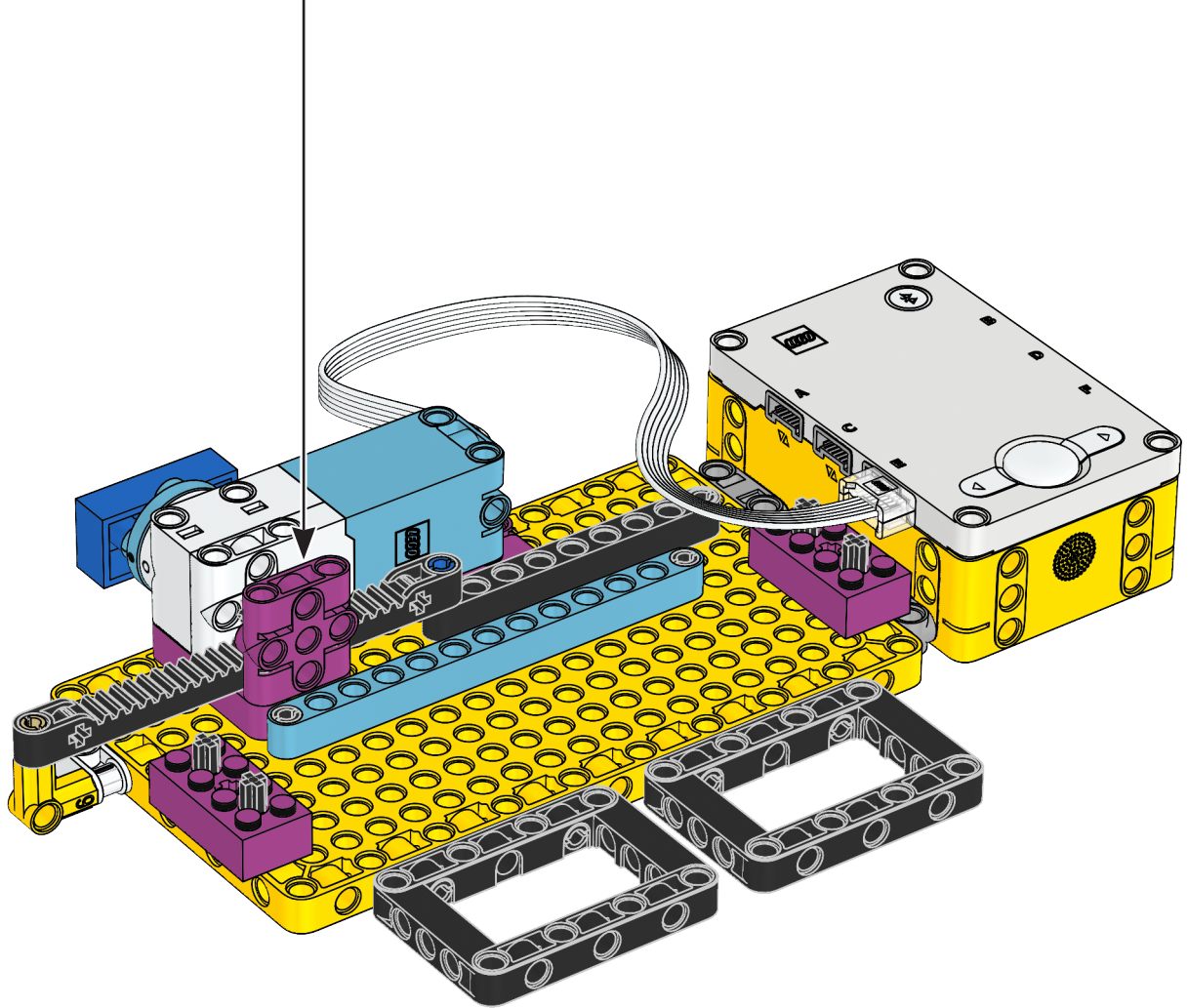



6x

10

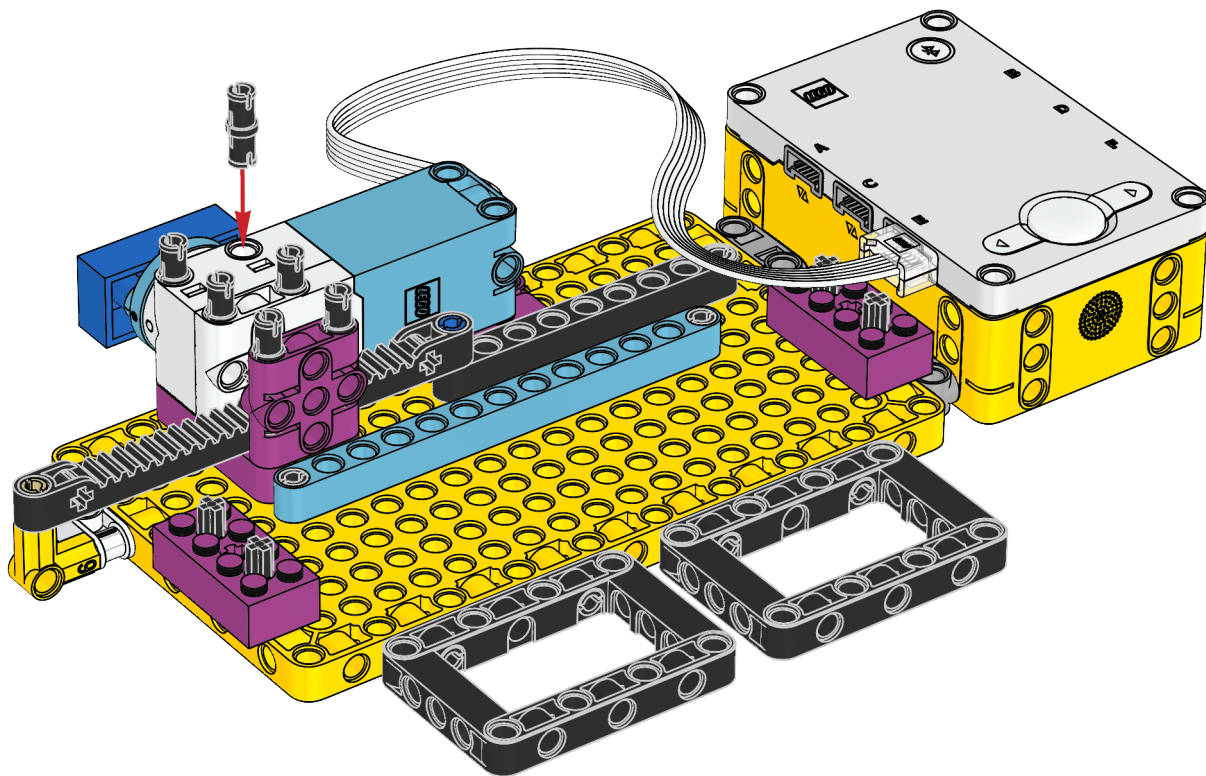

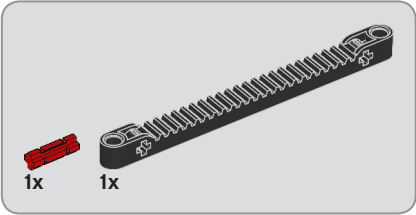
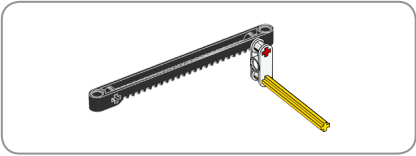

11





1x

12



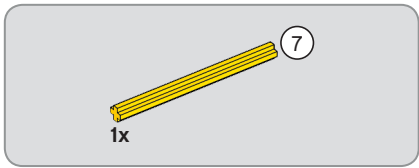

13

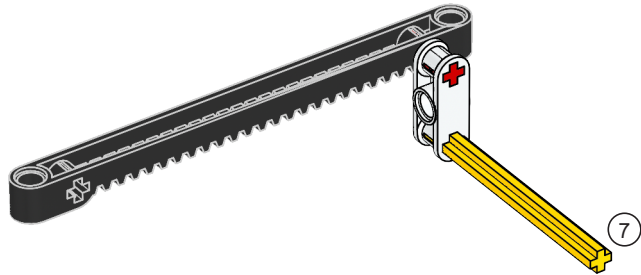

14

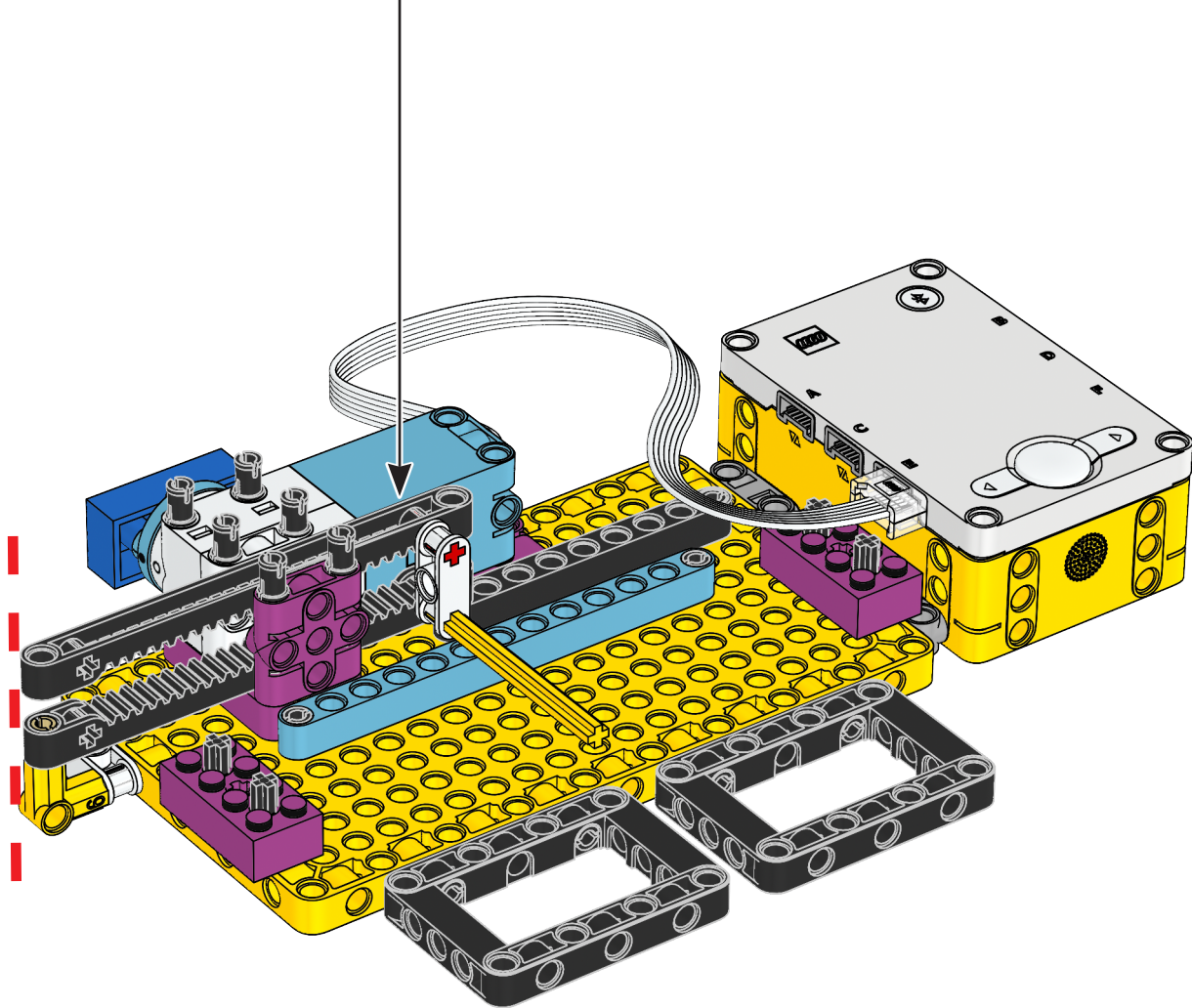



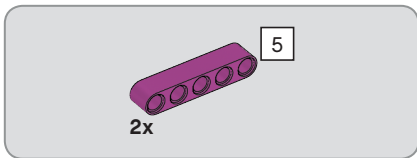

15

