

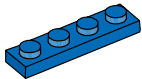

LEGO® Element Survey



8x
底板, 1x2, 蓝色
302323



4x
底板, 1x4, 蓝色
371023

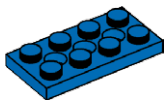

6x
带孔底板, 2x4, 蓝色
370923

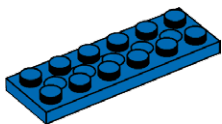

8x
带孔底板, 2x6, 蓝色
4114027

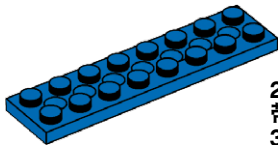

2x
带孔底板, 2x8, 蓝色
373823



4x
凸点横梁, 1x2, 蓝色
370023

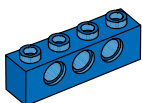

4x
凸点横梁, 1x4, 蓝色
370123

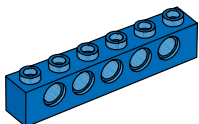

4x
凸点横梁, 1x6, 蓝色
389423

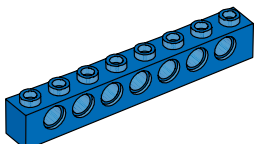

4x
凸点横梁, 1x8, 蓝色
370223



10x
3 个单位摩擦销,
3 个模块, 蓝色
4514553

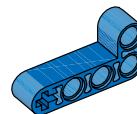

8x
角梁, 4x2 个模块, 蓝色
4168114

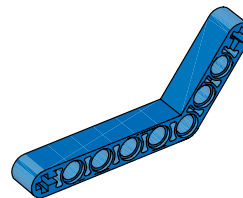

4x
角梁, 4x6 个模块, 蓝色
4182884

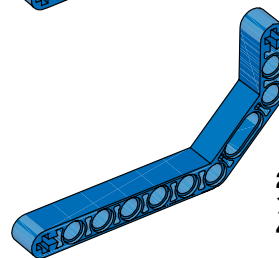

2x
角梁, 3x7 个模块, 蓝色
4112000

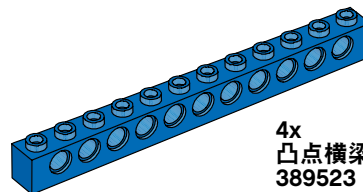

4x
凸点横梁, 1x12, 蓝色
389523

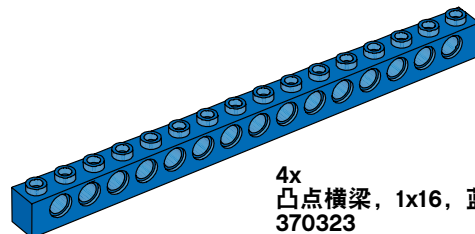

4x
凸点横梁, 1x16, 蓝色
370323



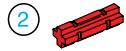

14x
轴, 2 个单位轴, 红色
4142865

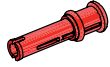

14x
带轴衬的连接销, 红色
4140806



4x
带棱角的积木, 2 (180°), 红色
4234429



10x
带交叉孔的带棱角的积木, 红色
4118897

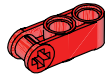

4x
交叉块, 3 个模块, 红色
4175442



2x
管, 2 模块, 红色
4526984



4x
凸点横梁, 1x2 (带交叉孔), 白色
4233486



2x
积木, 2x4, 白色
300101



2x
积木, 2x2 (圆形), 白色
614301



4x
顶部积木, 1x2/45°, 白色
4121932

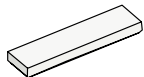

2x
瓦, 1x4, 白色
243101

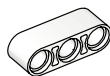

2x
3 单位连杆, 白色
4208160

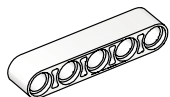

2x
5 单位连杆, 白色
4249021

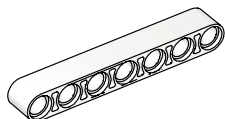

2x
7 单位连杆, 白色
4495927

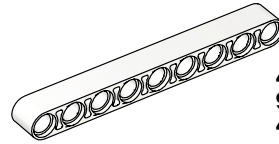

4x
9 单位连杆, 白色
4156341

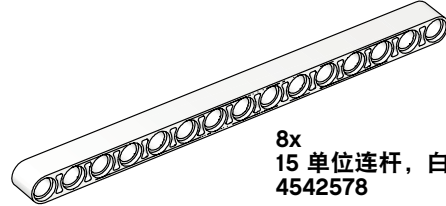

8x
15 单位连杆, 白色
4542578



2x
转向臂, 黑色
4114670



2x
转向臂轴承, 黑色
4114671



4x
带棱角的积木, 1 (0°), 深灰色
4210658



4x
带棱角的积木, 3 (157.5°), 黑色
4107082



28x
摩擦销, 黑色
4121715



4x
轮胎, 30, 4x4, 黑色
281526



4x
轮胎, 30, 4x14, 黑色
4140670



4x
轮胎, 43, 2x22, 黑色
4184286





12x
轴销, 米黄色
4186017



4x
三单位光滑连接销, 米黄色
4514554



16x
半轴套, 1/2 个模块, 黄色
4239601

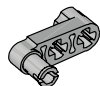

4x
连接销, 把手, 灰色
4211688



8x
光滑, 灰色
4211807



16x
全轴套, 灰色
4211622



8x
轴扩展器, 2 个模块, 灰色
4512360

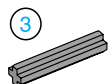

8x
3 个单位轴, 灰色
4211815

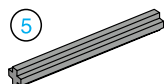

4x
5 个单位轴, 灰色
4211639



8x
4 个单位轴, 黑色
370526



2x
6 个单位轴, 黑色
370626



2x
8 个单位轴, 黑色
370726

10

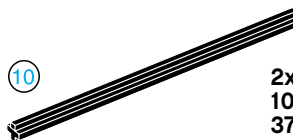

2x
10 个单位轴, 黑色
373726

12

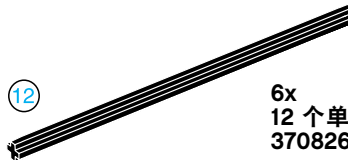

6x
12 个单位轴, 黑色
370826



1x
人仔, 马尾假发, 黑色
609326



1x
人仔, 帽子, 红色
448521



2x
人仔, 头, 黄色
9336



1x
人仔, 身体, 白色 (带冲浪图案)
4275606



1x
人仔, 身体, 白色 (带花朵图案)
4275536

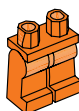

1x
人仔, 双腿, 橙色
4120158

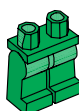

1x
人仔, 双腿, 绿色
74040





2x
齿轮, 16 个齿, 灰色
4211563

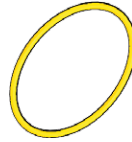

2x
皮带, 33 mm, 黄色
4544151

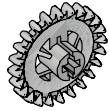

4x
齿轮, 24 个齿冠, 灰色
4211434



2x
皮带, 24 mm, 红色
4544143

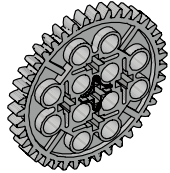

2x
齿轮, 40 个齿, 灰色
4285634



2x
皮带, 15 mm, 白色
4544140

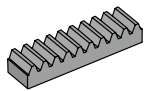

2x
齿轮, 10 个模块, 灰色
4211450

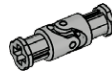

1x
万向接头, 3 个模块, 灰色
4525904



2x
蜗轮, 灰色
4211510



4x
轮毂, 18x14, 灰色
4490127



1x
差速器, 28 个齿, 深灰色
4525184



4x
轮毂, 24x4, 灰色
4494222



4x
24 齿, 深灰色
4514558

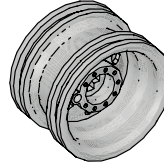

4x
轮毂, 30x20, 灰色
4297210



6x
8 齿, 深灰色
4514559



6x
连接销, 1/2 个模块,
深灰色
4211050



2x
12 齿 (双斜), 黑色
4177431

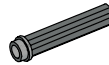

4x
带旋钮的轴, 3 个模块,
深灰色
4211086

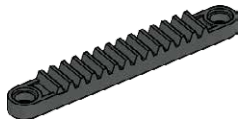

1x
齿条, 黑色
4275503



4x
凸轮, 深灰色
4210759



6x
齿轮, 12 个锥齿, 米黄色
4514556



1x
缠线管, 深灰色
4239891



2x
齿轮, 20 个锥齿, 米黄色
4514557

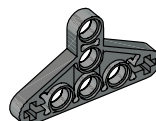

2x
1/2 横梁, 三角形, 深灰色
4210689



2x
齿轮, 20 个双斜齿, 米黄色
4514555



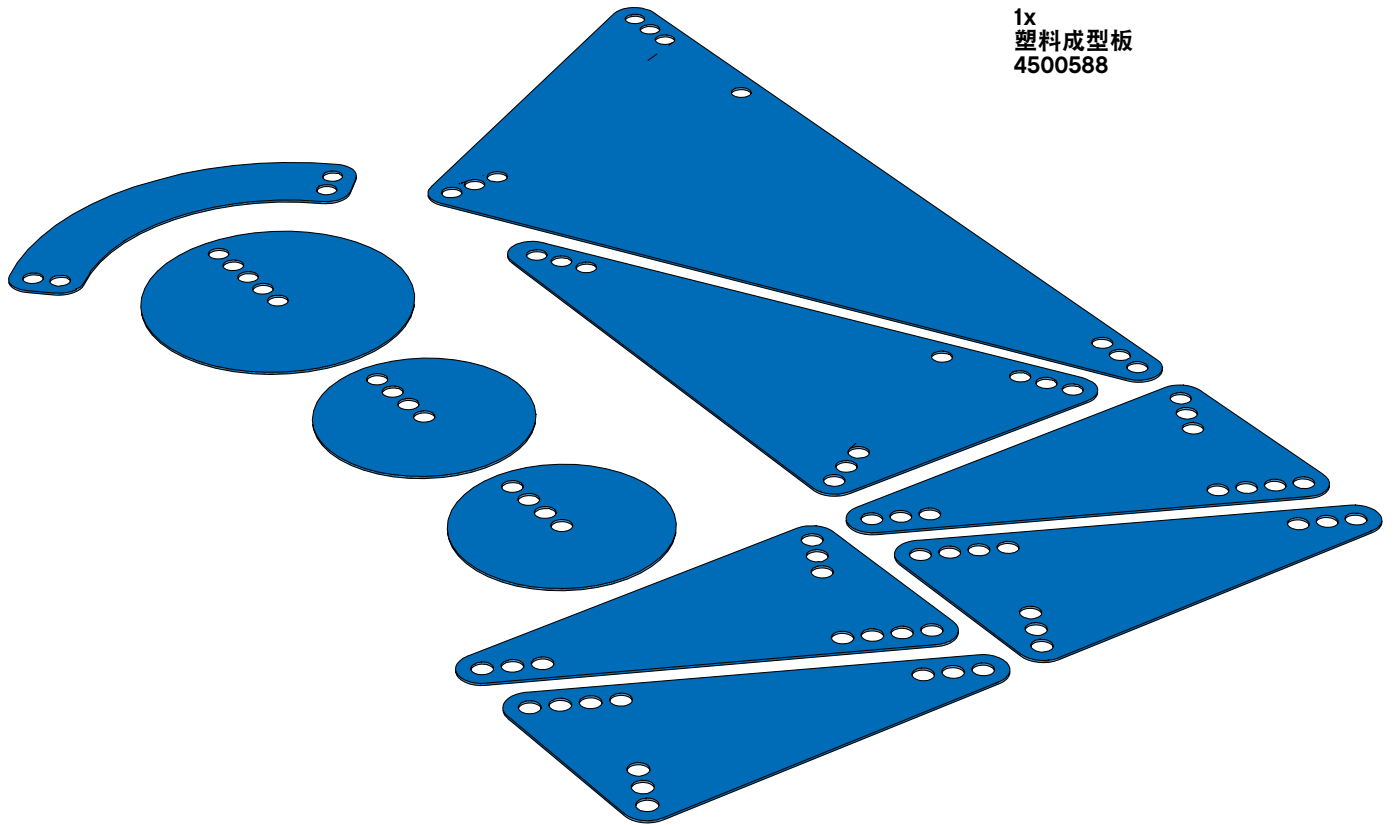

2x
细绳, 40 个带旋钮的模块, 黑色
4528334

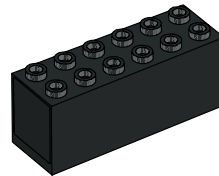

1x
砵码零件, 黑色
73843



1x
细绳, 2 m, 黑色
4276325

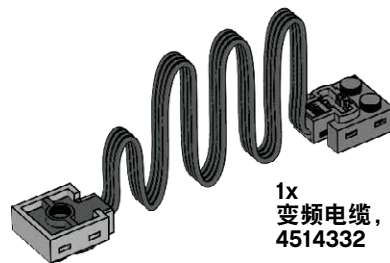

1x
变频电缆, 黑色
4514332

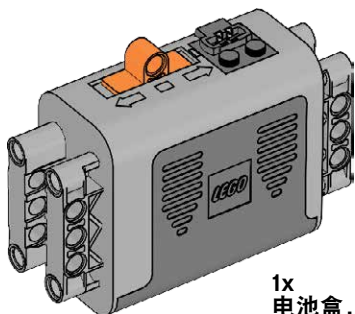

1x
电池盒, 9V, 灰色
4506078

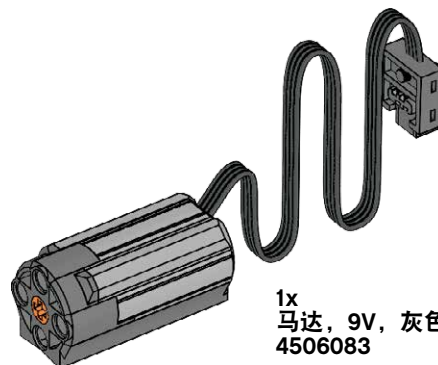

1x
马达, 9V, 灰色
4506083